

Dainty Roses

Web site: <http://www.superlativestitchery.com>

Copyright: Tina Gibbons

INSTRUCTIONS:

Starting at bottom of pattern chain 136. Chain 3 to turn which will count as first double crochet of first row. Double crochet in 5th chain from hook. Double crochet in next 2 chains to complete bottom right solid square of row 1. Continue following pattern for first row reading pattern right to left. After completing first row, chain 3 to turn to start next row. Continue following pattern until all rows are complete. At end of row 75 fasten off. For how to increase or decrease select "Advanced crochet instructions" under the Page menu.

MATERIALS (based on crochet cotton size):

Using Worsted Weight: about 1114 yds, steel crochet hook US size I or SIZE FOR GAUGE.

APPROXIMATE FINISHED SIZES:

Using Worsted Weight: width = 46.2 inches, height = 50.8 inches

GAUGE:

Using Worsted Weight: 10 squares = 10.3 inches, 10 rows = 6.8 inches

HOW TO READ PATTERN:

Each solid square is equal to 4 double crochets. Each open square is equal to 1 double crochet, followed by 2 chains, followed by 1 double crochet. The double crochet at the end of each square also counts as the first double crochet of the next square. For example, a solid square followed by an open square is 4 double crochets, 2 chains, 1 double crochet. See diagrams below:

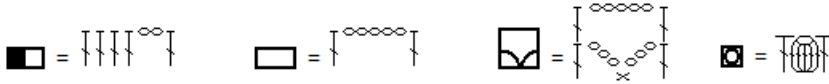

Where "}" is the symbol for one double crochet, "o" is the symbol for one chain, and "x" is the symbol for one single crochet.

Dainty Roses

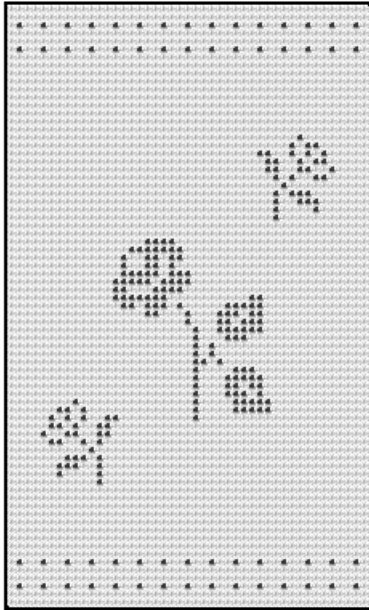

Copyright Tina Gibbons

Dainty Roses

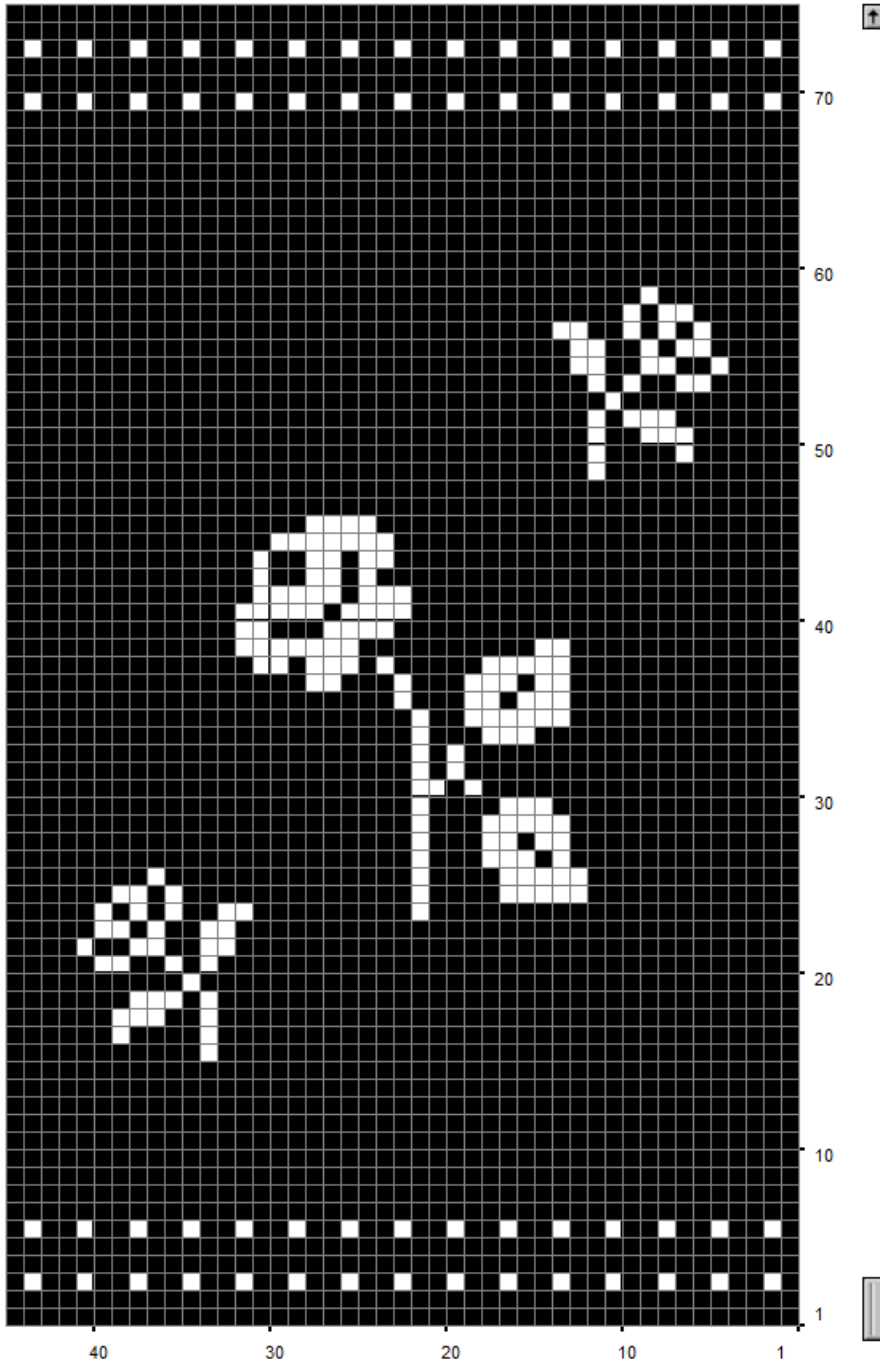

Copyright Tina Gibbons

NOT FOR RESALE OR DISTRIBUTION

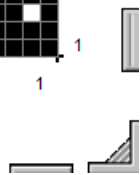

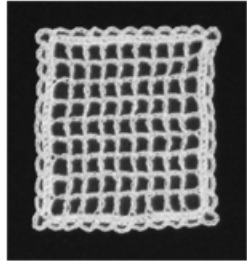
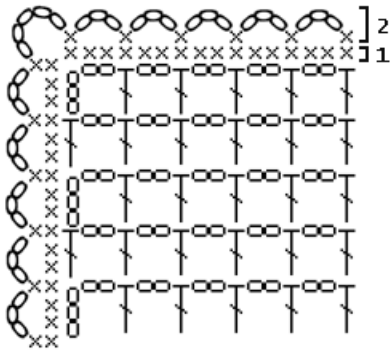

Edge Pattern 1

Follow the diagram completely around pattern. Complete each row as numbered on diagram.
 Pattern size: This edge pattern works for any size pattern.

Sample Pattern Edges

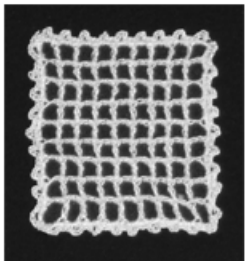
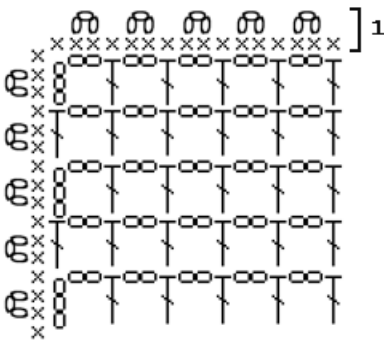

Edge Pattern 5

Follow the diagram completely around pattern. Complete each row as numbered on diagram.
 Pattern size: This edge pattern works for any size pattern.

Where "D" is the symbol for one double crochet, "C" is the symbol for one chain, and "S" is the symbol for one single crochet.



www.superlativestitchery.com

Learn to follow my graph patterns
HEART SAMPLE PATTERN COPYRIGHT TINA GIBBONS

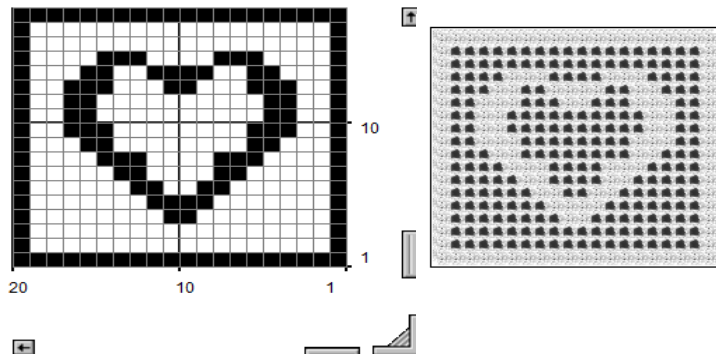

Heart sample pattern first 4 rows

Row 1

Chain 61, this is because the rule for the starting chain is multiply the number of squares in the first row by 3 and then add 1, so $(20 \times 3) + 1 = 61$ chains. Chain 3 to turn, this counts as first double crochet of first square, first row, double crochet in 5th chain from your hook, this is second double crochet, first square, first row. Double crochet in next two chains, this completes first square, first row. There are 61 double crochets for the first row. The first square counts as 4 double crochet, all remaining count as 3 double crochet, $(19 \times 3) + 4 = 61$.

Row 2

Now, chain 3 to turn, this counts as first double crochet of first square, second row, double crochet in 5th chain from your hook, this is second double crochet, first square, second row. Double crochet in next two chains, this completes first square, second row. By the way, you are following left to right now. Odd rows are right to left, even rows are left to right. So, after the first square in the second row there are 18 open squares, which means each square counts as chain two then double crochet, this does indeed take up 3 spaces for each square, and then the last or 20th square in that row counts as 3 double crochet, adding up once again to 61 stitches, there should be 61 in every row.

The third row, same directions as second row, but following graph right to left, which brings you to the end of row 3, chain 3 to turn which will count as your first double crochet in row 4, double crochet in 5th chain from your hook, this counts as second double crochet of first square of row, double crochet in next two chains, this completes square one of fourth row. Left to right there are now 8 open squares which count as chain 2 double crochet, and then you come to two solid squares which equal 3 double crochets each, so at that point you should have 7 double crochets in a row, and continue with 8 more open squares, each chain two double crochet, so this brings you to the 20th square, solid, equaling 3 double crochet. So, at the beginning and end of each row there should be 4 double crochets together.

HELPFUL HINTS FOR ALL BLACK AND WHITE GRAPHS: Chain as many as stated, (for above examples sake, chain 61), chain 3 to turn, (this counts as 1st double crochet), double crochet in 5th chain from hook, (2nd double crochet), then double crochet in next two chains (3rd and 4th double crochet), this completes first square in first row. IF THE SECOND SQUARE IS OPEN then it counts as chain 2 then double crochet. Each following open square counts as chain 2 then double crochet. When you reach a solid square it counts as 3 double crochet, and the next square counts as chain 2 then double crochet for open square OR 3 double crochet for each following consecutive solid squares. IF THE SECOND SQUARE IS SOLID then it counts as 3 double crochet. Each following solid square counts 3 double crochet. When you reach an open square it counts as chain 2 then double crochet, and the next square counts as chain 2 then double crochet for open square OR 3 double crochet for following consecutive solid squares. You should have 61 stitches (CHAINS) when finished in every row.

Need more help? Email me @ tinagibbons@superlativestitchery.com

Dainty Roses

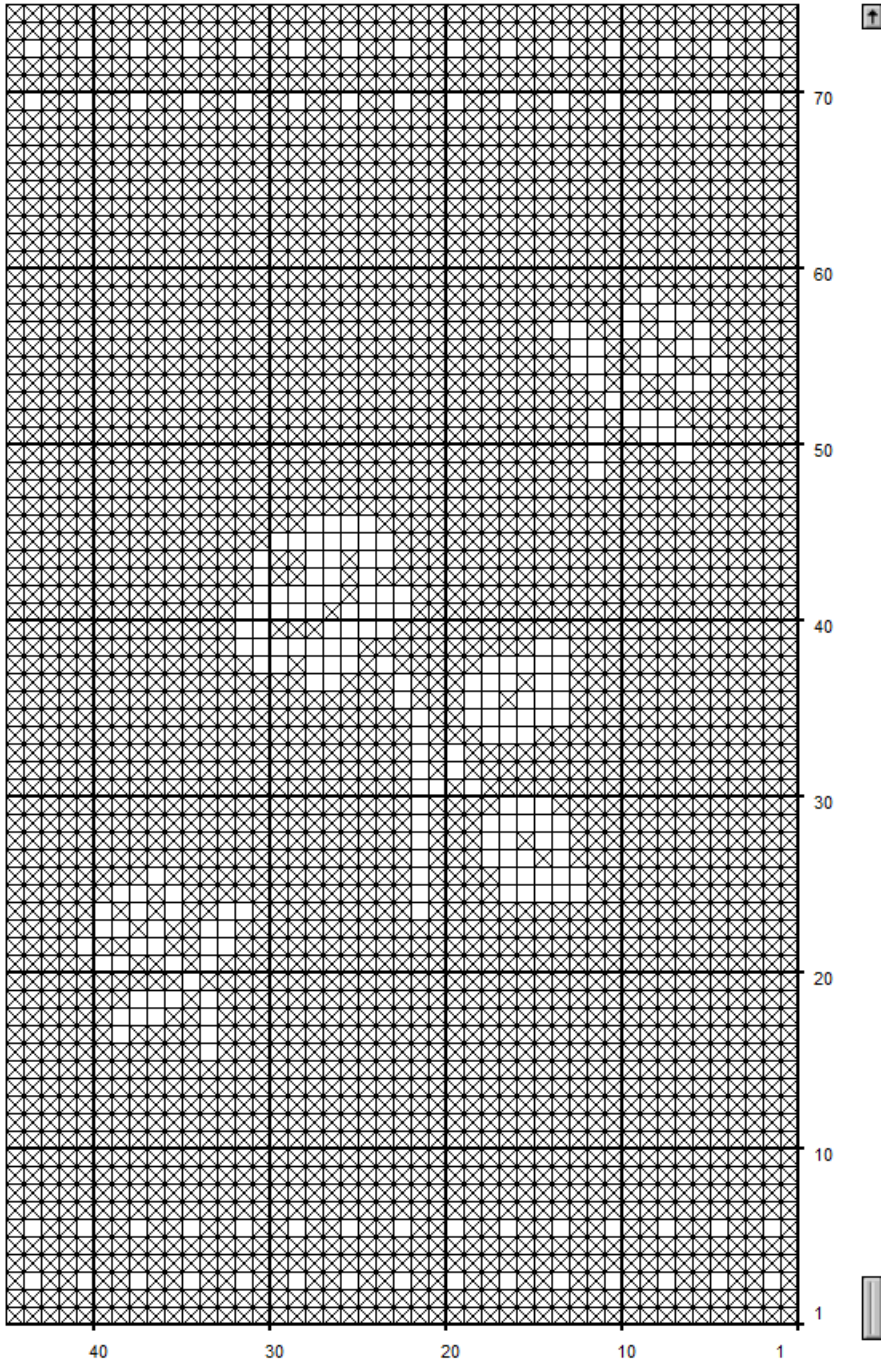

Copyright Tina Gibbons

